

## Retro-commissioning (RCx)

### Example 1 - Chiller Sequencing Optimization

- ESO: Improving COP – More chillers operated at partial load



#### Facility / Equipment



#### Observation

- 4 sets of VSD air-cooled chillers (3 duty & 1 standby) with 4 sets of chilled water pumps (3 duty & 1 standby)

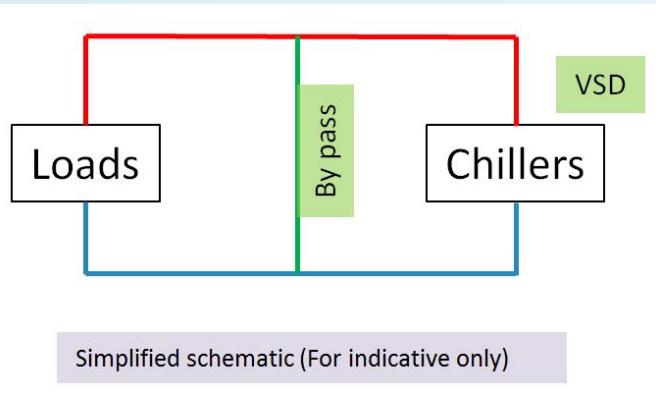

# Retro-commissioning (RCx)

## Example 1 - Chiller Sequencing Optimization

- ESO: Improving COP – More chillers operated at partial load



### Facility / Equipment

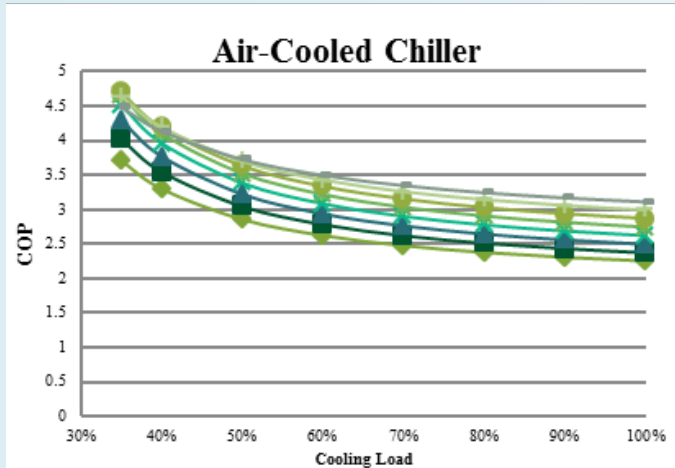

### Principle

- VSD air-cooled chiller has higher COP in part load condition

VSD Air-cool chiller's performance curves under different condensate water temp.

# Retro-commissioning (RCx)

## Example 1 - Chiller Sequencing Optimization

- ESO: Improving COP – More chillers operated at partial load



### Facility / Equipment

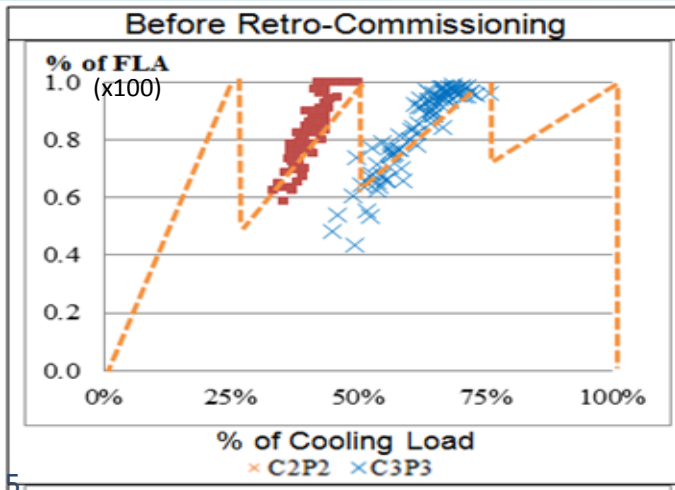

### Observation

- Two chiller combinations ( 2 chillers and 3 chillers ) have been used between an overall loading of 30%-50% loading.

## Retro-commissioning (RCx)

### Example 1 - Chiller Sequencing Optimization

- ESO: Improving COP – More chillers operated at partial load



#### Facility / Equipment



#### Recommendation

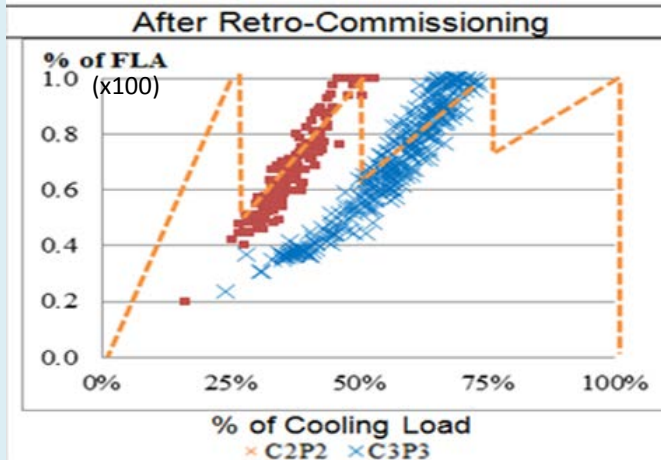

- Three chillers are now used between an overall loading of 30%-50% loading.

## Retro-commissioning (RCx)

### Example 1 - Chiller Sequencing Optimization

- ESO: Improving COP – More chillers operated at partial load

Before

After

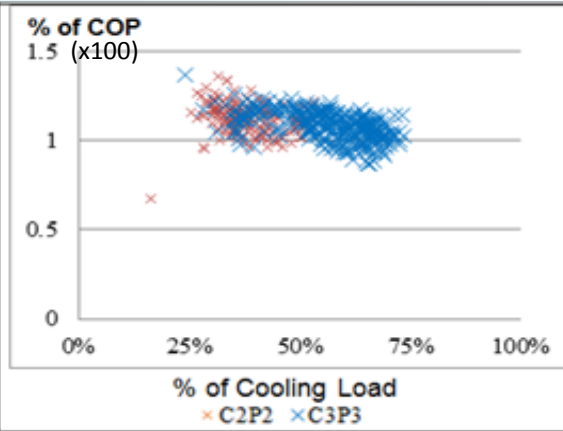
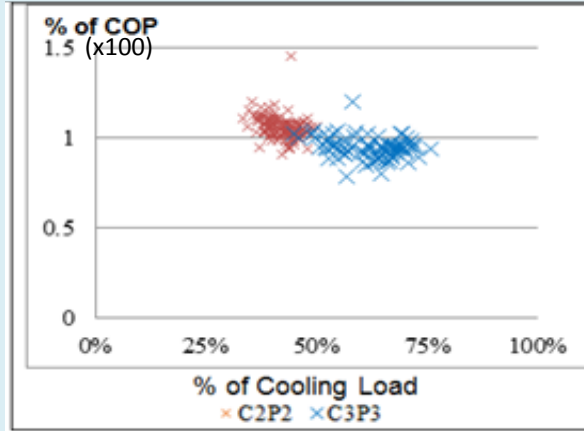

Remarks:

100% of COP = Baseline COP (before RCx) = 3.39

108.2% of COP = Improved COP (after RCx) = 3.67

Average COP: 3.39

Average COP: 3.67

## Retro-commissioning (RCx)

### Example 2 - Chiller Sequencing Optimization

ESO: Prevent the activating of low-cut function of the oil-free chiller at light load operation



#### Facility / Equipment



#### Observation

- The building is served by 2 sets of air-cooled chiller (1 duty & 1 standby). One of the chillers is an oil-free centrifugal chiller (the duty chiller - new) with 2 compressors and the other one is an air-cooled screw chiller (the standby chiller - old) with 4 compressors.

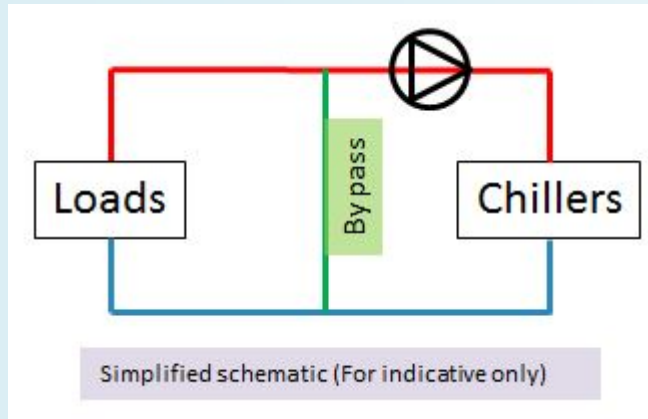

# Retro-commissioning (RCx)

## Example 2 - Chiller Sequencing Optimization

ESO: Prevent the activating of low-cut function of the oil-free chiller at light load operation



### Facility / Equipment

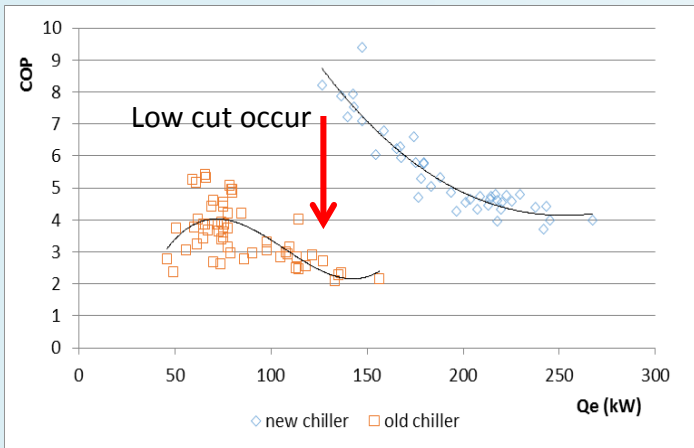

### Observation

- During peak seasons, the oil-free chiller were only running at about 50-60%
- Because it is a constant pump speed differential pressure bypass system, the chilled water temperature difference is only about 3 deg C or below resulting from the large amount of chilled water needed to be bypassed back to the chiller.

## Retro-commissioning (RCx)

### Example 2 - Chiller Sequencing Optimization

ESO: Prevent the activating of low-cut function of the oil-free chiller at light load operation



#### Facility / Equipment

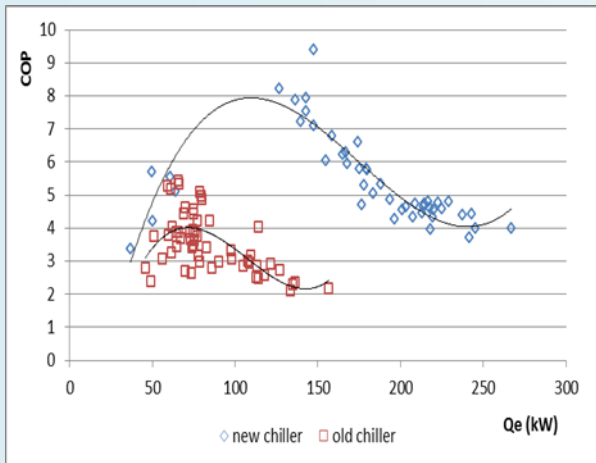

#### Recommendation

- Modify the low temperature cut control so that the chiller will be switched to standby mode (with the compressor stopped) instead of tripping the chiller when the chiller water is lower than the cut-off temperature.
- Maintain the chilled water temperature difference across the chiller not less than 5 deg.C by converting the system to primary variable flow



# Retro-commissioning (RCx)

## Example 3 - Air-conditioning (Central Chiller plant)

- ESO: ESO: Adjust the chiller's load factor by CHWST setpoint reset in order to improve chiller efficiency



### Facility / Equipment

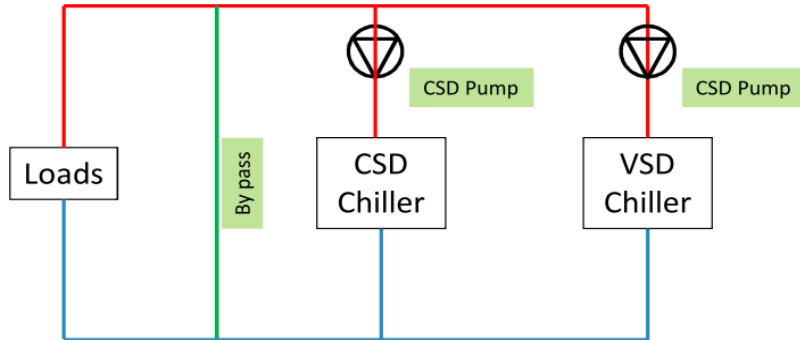

### Observation Existing chiller load distribution

	Chiller 1	Chiller 2
Type of Chiller	CSD	VSD
Existing CHWST Setpoint	7 deg C	7 deg C
Existing Distribution of Chiller Average Load Factor	60%	60%

# Retro-commissioning (RCx)

## Example 3 - Air-conditioning (Central Chiller Plant)

- ESO: Adjust the chiller's load factor by CHWST setpoint reset in order to improve chiller efficiency



### Facility / Equipment

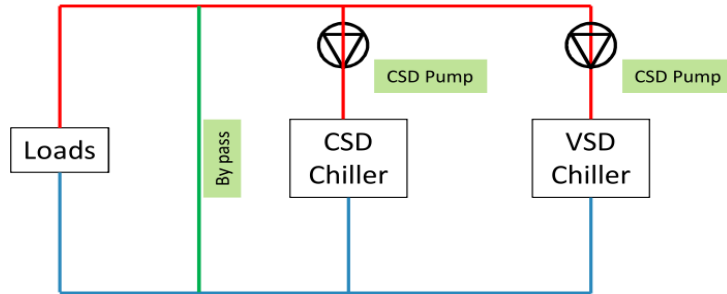

### Observation

#### Existing monthly COP of chillers

	Jan	Feb	Mar	Apr	May	Jun	Jul	Aug	Sep	Oct	Nov	Dec
Chiller 1 (CSD) COP	NA	NA	NA	4.04	3.97	3.56	3.56	3.56	3.56	3.97	3.85	NA
Chiller 2 (VSD) COP	5.36	5.36	4.8	4.19	4.38	3.81	3.68	3.68	3.68	4.38	4.64	6.22

# Retro-commissioning (RCx)

## Example 3 - Air-conditioning (Central Chiller Plant)

- ESO: Adjust the chiller's load factor by CHWST setpoint reset in order to improve chiller efficiency



### Recommendation COP Curve of CSD chiller

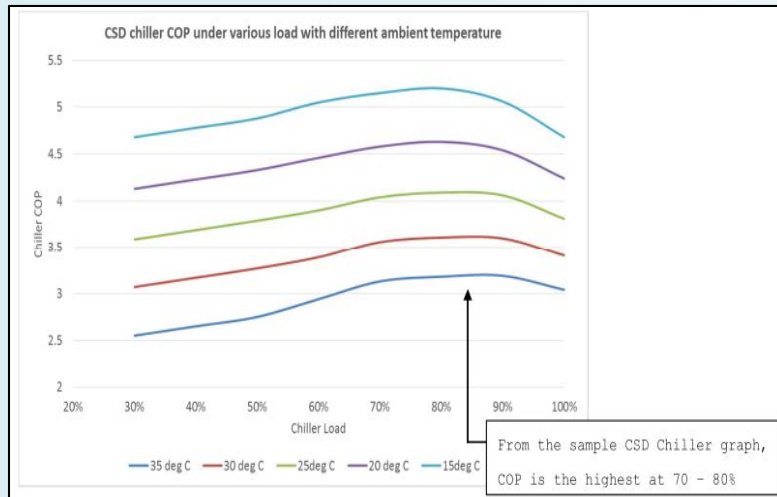

### COP Curve of VSD chiller

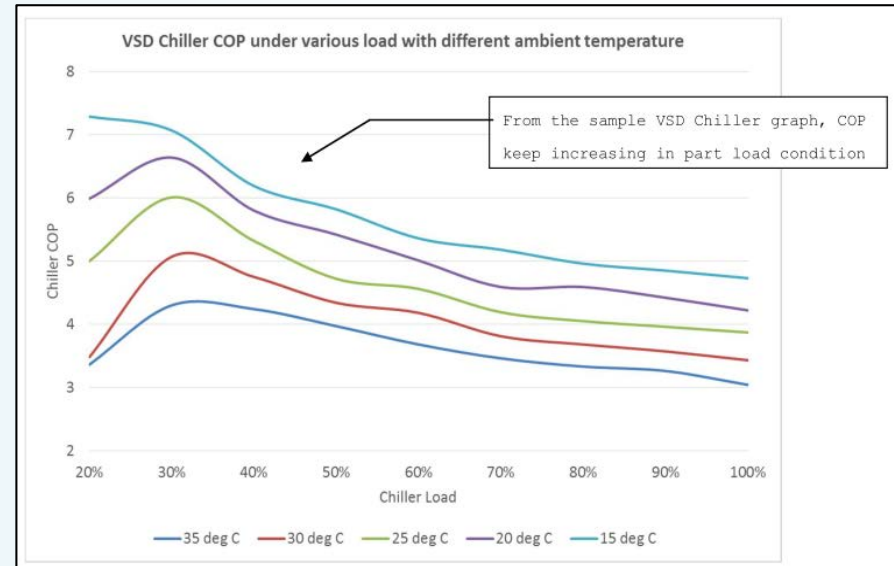

## Retro-commissioning (RCx)

### Example 3 - Air-conditioning (Central Chiller Plant)

- ESO: Adjust the chiller's load factor by CHWST setpoint reset in order to improve chiller efficiency



#### Proposed chiller load distribution

	Chiller 1	Chiller 2
Type of Chiller	CSD	VSD
Proposed CHWST Setpoint	6.5 deg C	7.5 deg C
Proposed Distribution of Chiller Average Load Factor	70%	50%

#### Proposed COP of chillers

	Jan	Feb	Mar	Apr	May	Jun	Jul	Aug	Sep	Oct	Nov	Dec
Chiller 1 (CSD) COP	NA	NA	NA	4.07	4.07	3.61	3.61	3.61	3.61	4.07	3.97	NA
Chiller 2 (VSD) COP	5.36	5.36	4.8	4.56	4.64	4	4	4	4	4.64	4.72	6.22

# Retro-commissioning (RCx)

## Example 3 - Air-conditioning (Central Chiller Plant)

- ESO: Adjust the chiller's load factor by CHWST setpoint reset in order to improve chiller efficiency



### Energy saving

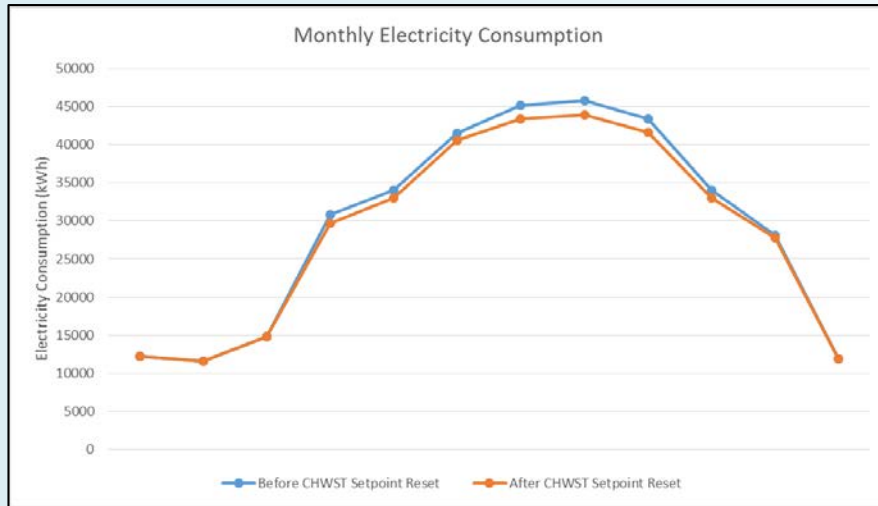

- Annual electricity consumption before RCx: 353,370kWh
- Annual electricity consumption after RCx: 343,450kWh
- Savings 9,920kWh ( ~3% of annual chiller electricity consumption)

# Retro-commissioning (RCx)

## Example 4 - Air-conditioning (Central Chiller Plant)

- ESO: Evaluating existing chiller plant performance with retrofitting consideration



### Facility / Equipment

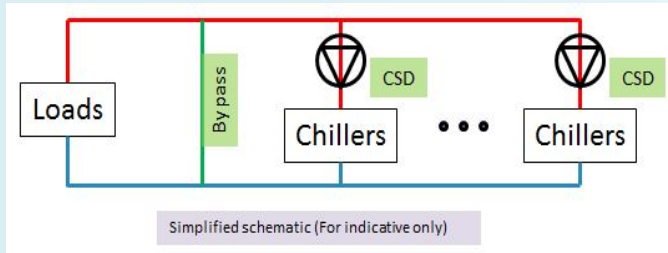

### Observation

- 4 sets of chillers in operation
- Some compressors are out of order
- The chillers are operating at 85% of full load current

# Retro-commissioning (RCx)

## Example 4 - Air-conditioning (Central Chiller Plant)

- ESO: Evaluating existing chiller plant performance with retrofitting consideration



### Facility / Equipment

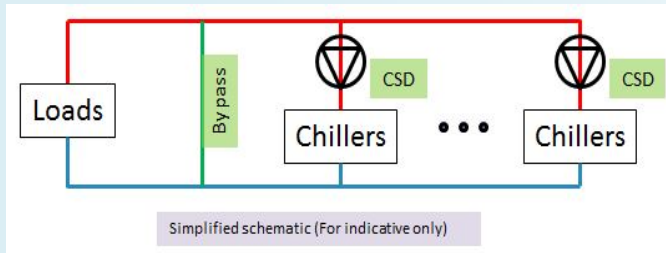

### Observation

- Chilled water supply temp. unable to meet the set point 8.5 deg.C
- Differential bypass pipes cannot manually closed leading to 3.5 deg.C temp. difference of CHWS and CHWR
- The constant flow chilled water pumps were connected directly to individual chillers without a common header (less flexibility in controlling the flow through chillers)

# Retro-commissioning (RCx)

## Example 4 - Air-conditioning (Central Chiller Plant)

- ESO: Evaluating existing chiller plant performance with retrofitting consideration



### Findings

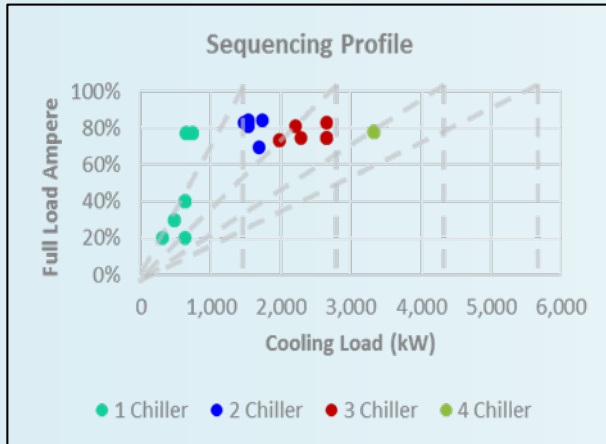

- Figure 3a: more chillers than required to cater for the loading

Figure 3a Full load Ampere Vs cooling load



# Retro-commissioning (RCx)

## Example 4 - Air-conditioning (Central Chiller Plant)

- ESO: Evaluating existing chiller plant performance with retrofitting consideration



### Findings

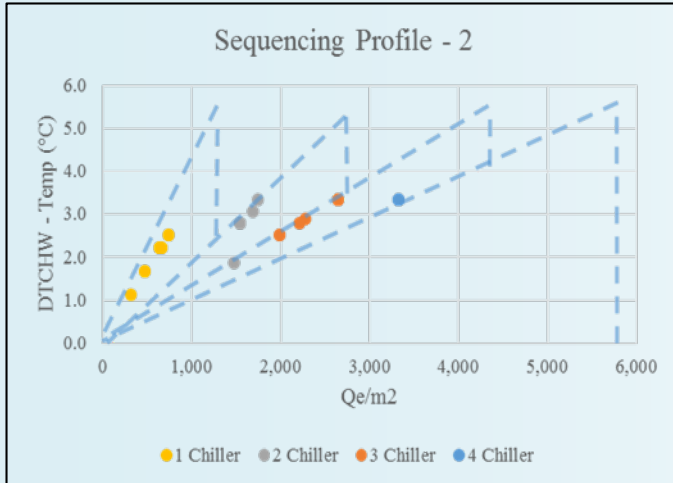

- Figure 3b: a very low chilled water temperature difference (< 3 deg C) across chillers

Figure 3b Temp difference between CHWR and CHWS

# Retro-commissioning (RCx)

## Example 4 - Air-conditioning (Central Chiller Plant)

- ESO: Evaluating existing chiller plant performance with retrofitting consideration



### Recommendation

- To replace chillers
- To convert the chilled water system with a variable flow system



### Recommendation

	Original	Option 1	Option 2	Option 3
Chiller	4 x 400 TR Air-cooled (VSD)	3 x 400 TR Air-cooled (VSD)	2 x 400 TR Air-cooled (VSD)	2 x 450 TR Air-cooled (VSD)
Estimated Payback	9-10 years	8 years	6 years	5.5-6 years
Annual Saving (kWh)	1,365,000	1,365,000	1,210,000	1,490,000

## Retro-commissioning (RCx)

### Example 5 - Air-conditioning (Central Chiller Plant)

- ESO: To upgrade chiller plant control system in order to improve energy efficiency operation



#### **Background Information**

- 1 set of 1000 kW air-cooled screw type chiller and 2 sets of 1000 kW heat recovery screw type chillers for day-mode or high-demand operation time.
- 4 nos. of 9.0kW primary pumps and 3 nos. of 34.0kW secondary chilled water pumps
- In night mode operation, 2 sets of air-cooled packaged screw heat pumps (300 kW) are operated with 3 nos. of 9.0 kW primary chilled water pumps

## Retro-commissioning (RCx)

### Example 5 - Air-conditioning (Central Chiller Plant)

- ESO: To upgrade chiller plant control system in order to improve energy efficiency operation



#### Facility / Equipment



#### Observation

- The flow meters could not provide accurate readings
- The control logic of chiller plant could not be identified
- On site measurement on chilled water flow rate and not tally with CCMS

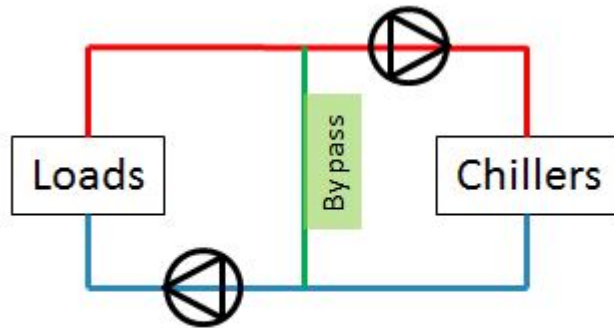

Simplified schematic (For indicative only)

# Retro-commissioning (RCx)

## Example 5 - Air-conditioning (Central Chiller Plant)

- ESO: To upgrade chiller plant control system in order to improve energy efficiency operation



### Facility / Equipment

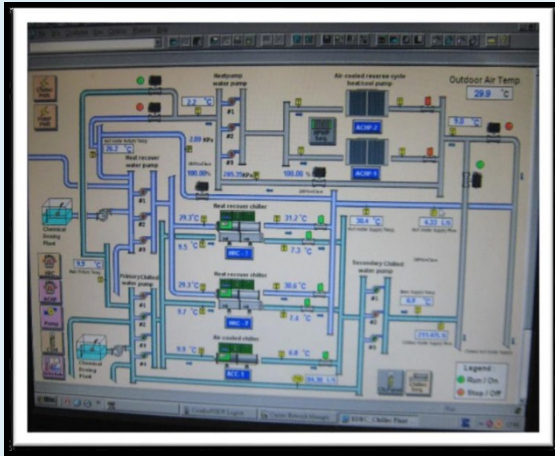

Chiller Plant



### Recommendation

- To repair/ replace the water flow sensors
- To develop a proper control sequencing of chillers to meet the actual cooling load and improve the chiller performance

# Retro-commissioning (RCx)

## Example 5 - Air-conditioning (Central Chiller Plant)

- ESO: To upgrade chiller plant control system in order to improve energy efficiency operation

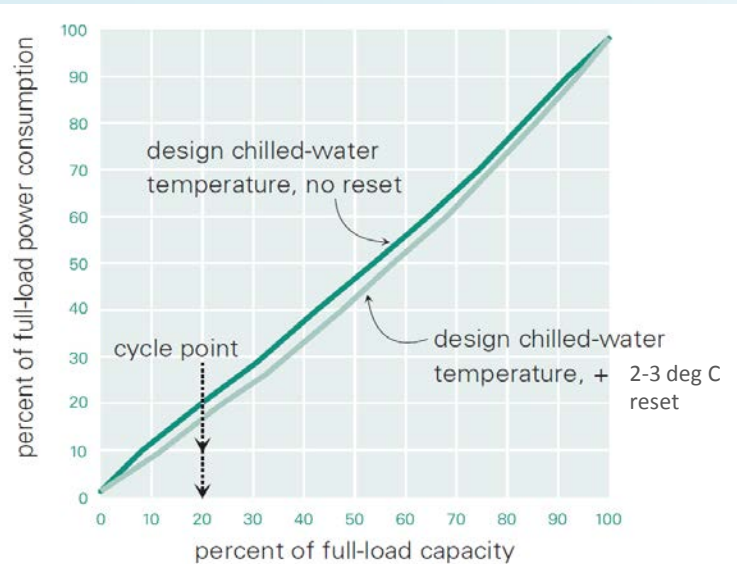

### Principle

- To reset chiller water supply temperature at a higher value under partial load condition can reduce energy consumption of chiller

# Retro-commissioning (RCx)

## Example 5 - Air-conditioning (Central Chiller Plant)

- ESO: To upgrade chiller plant control system in order to improve energy efficiency operation

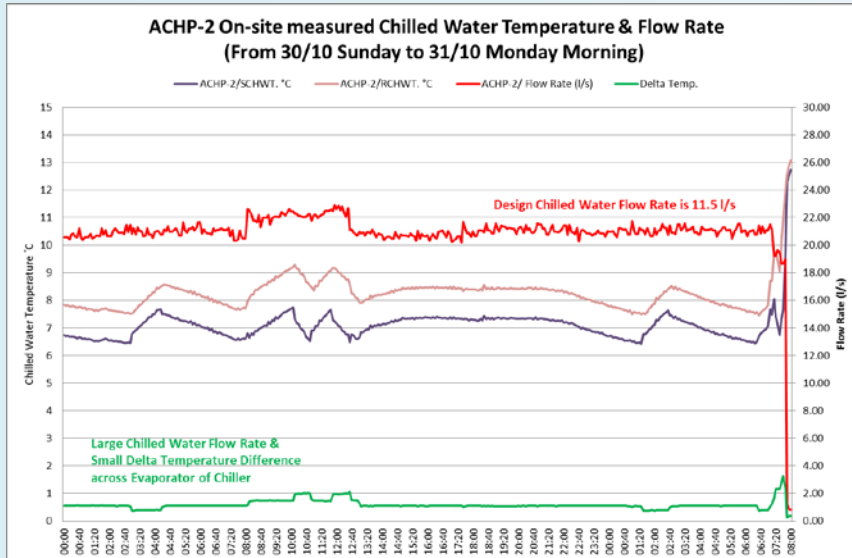

### Principle

- By operating the chillers at the designated chilled water supply and return temperature, excessive pump energy required for surplus chilled water flowrate can be avoided.

## Retro-commissioning (RCx)

### Example 5 - Air-conditioning (Central Chiller Plant)

- ESO: To upgrade chiller plant control system in order to improve energy efficiency operation



**Energy Saving Estimation** (*Estimated Annual Energy Saving : 93,300 kWh*)  
(~ 5% of chiller plant annual energy consumption)

- Chilled water temperature reset (1.5°C) for day mode operation (Dec to Apr) => 10,000 kWh
- Reduction of operation for extra secondary chilled water pump (3 hrs saving on weekday from Jun to Nov) => 7,300 kWh
- Adjusted operation of night mode chiller & pump for equipment cooling (Dec to Apr) => 68,000 kWh
- Prevent extra pump operation of night mode chiller (May to Nov) => 8,000 kWh



## Retro-commissioning (RCx)

### Example 6 – Cooling Tower & Chillers Optimization

ESO: Reduce the condensing water entering temperature of chillers



#### Facility / Equipment

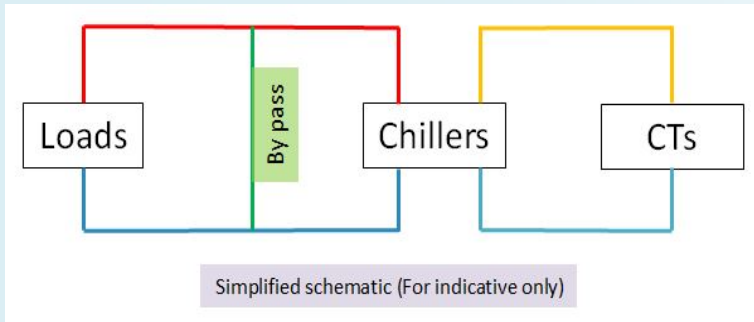

#### Observation

- 4 sets of centrifugal chiller (2 duty & 2 standby) with associated fresh water cooling towers and condensing water pumps connected in a one-to-one basis.
- The cooling towers, condensing water pumps and chillers are connected in series to common headers. Variable speed drives are installed for speed control of cooling tower fans.

# Retro-commissioning (RCx)

## Example 6 – Cooling Tower & Chillers Optimization

ESO: Reduce the condensing water entering temperature of chillers



### Facility / Equipment

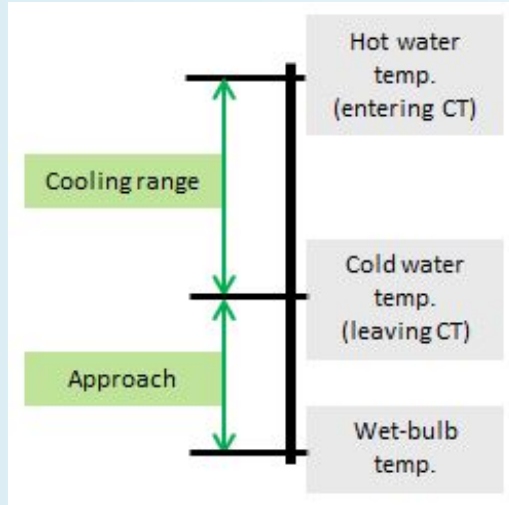

### Principle

- The approach temperature of cooling towers ranges from 6 deg C to 12 deg C.
- while the condensing water entering temperature has not dropped to below 26 deg C even when the wet-bulb temperature falls to below 20 deg C

# Retro-commissioning (RCx)

## Example 6 – Cooling Tower & Chillers Optimization

ESO: Reduce the condensing water entering temperature of chillers



### Observation

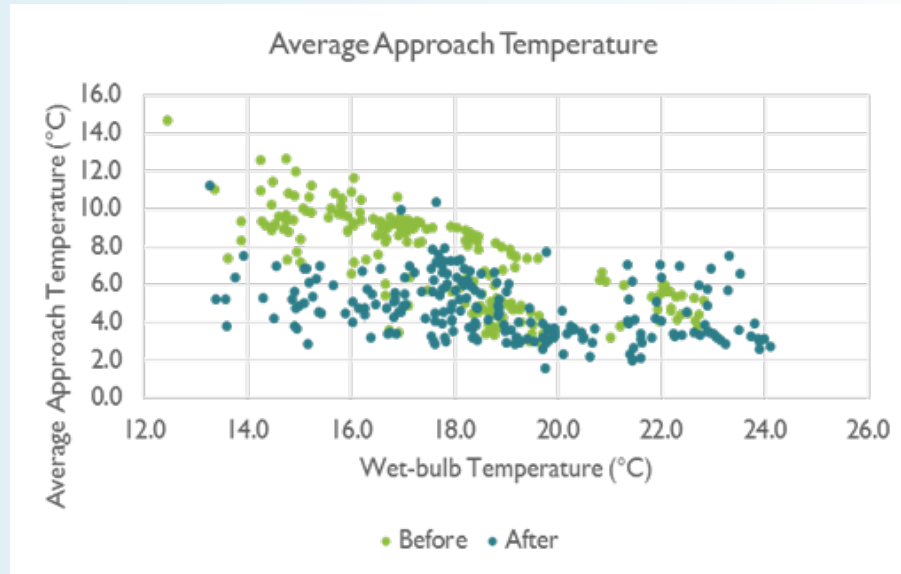

# Retro-commissioning (RCx)

## Example 6 – Cooling Tower & Chillers Optimization

ESO: Reduce the condensing water entering temperature of chillers



### Facility / Equipment

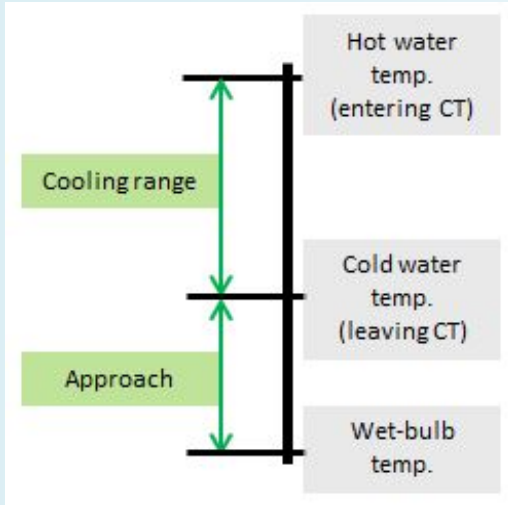

### Recommendation

- to decrease the approach temperature during periods with lower wet-bulb.
- When the average approach temperature is higher than the recommended value, one more cooling tower will be called on and the cooling tower fan speed will start from 30 Hz and will be increased when the approach temperature still cannot meet.

# Retro-commissioning (RCx)

## Example 7 – Air-conditioning (Air-side System)

- ESO: To adjust indoor room air temperature thermostat



### Facility / Equipment

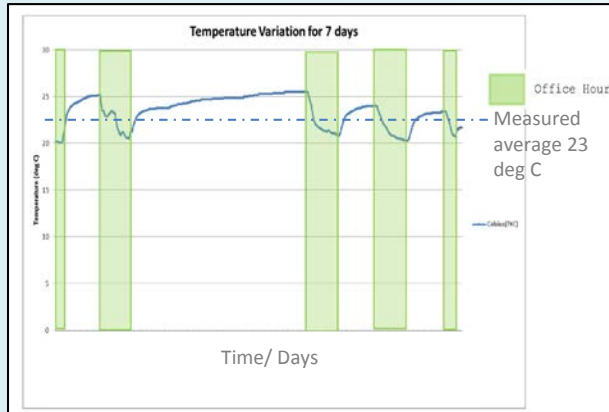

### Observation

- In an office, VAV system is adopted to serve the floor. The AHU supply air temperature is set to be 15 deg C in summer.
- Indoor room temp continues to drop due to the low set pt.
- Measure average indoor room temp is 23 deg C

# Retro-commissioning (RCx)

## Example 7 – Air-conditioning (Air-side System)

- ESO: To adjust indoor room air temperature thermostat



### Findings

- AHU supply air temperature: 15 deg C
- Measured average return air temperature: 23 deg C
- Daily Operation Hours: 8am to 6pm
- $DT_1 = 23 - 15 = 8$  deg C



### Recommendation

- Indoor room thermostat sets back to from 15 to 24 deg C
- Targeted average return air temperature: 24 deg C



# Retro-commissioning (RCx)

## Example 7 – Air-conditioning (Air-side System)

- ESO: To adjust indoor room air temperature thermostat



### Recommendations

#### ASHRAE Standard 90.1-2013 Table G3.1.3.15

Fan Part-Load Ratio	Fraction of Full-Load Power
0.00	0.00
0.10	0.03
0.20	0.07
0.30	0.13
0.40	0.21
0.50	0.3
0.60	0.41
0.70	0.54
0.80	0.68
0.90	0.83
1.00	1.00

### Site Measurement Findings

	Before RCx	After RCx
Measured Air Flow (L/s)	4450	3600
Fan Rated Flow (L/s)	4600	4600
Fan Part-Load Ratio	0.97	0.78
Fraction of Full Load Power	~0.95	~0.65

## Retro-commissioning (RCx)

### Example 7 – Air-conditioning (Air-side System)

- ESO: To adjust indoor room air temperature thermostat



### Energy Saving

Measured electricity consumption of all AHUs in that measurement hour (before RCx)  
= 590kW

Hourly Electricity Consumption after adjusting indoor air temperature set point hence reduces the AHU flowrate :  
= 404 kW

Assume the AHU operation from Monday to Friday, 8:00 to 18:00.  
Numbers of hour that can adopt with similar cooling load in annual: 662 hours

Calculated annual electricity saving of all AHUs after RCx = **123,132 kWh**– (A)

Measured annual electricity consumption saving of all AHUs before RCx = 1,348,950 kWh – (B)

**Annual AHU electricity consumption saving is around 9%.**



## Retro-commissioning (RCx)

### Example 8 - Air-conditioning (Air-side System)

➤ ESO: To adjust operation hours of Primary Air Handling Units

#### Background Information

- 4 nos. of Primary Air Handling Units (PAU) ranging from 5.8 m<sup>3</sup>/s to 9.2 m<sup>3</sup>/s
- Air Handling Units (AHU) serving conditioned spaces start operating from 8:00 a.m. on Tuesday to Friday whereas from 7:30 a.m. on Monday for morning start pre-cooling after weekend.

# Retro-commissioning (RCx)

## Example 8 - Air-conditioning (Air-side System)

➤ ESO: To adjust operation hours of Primary Air Handling Units



### Facility / Equipment



AHUs & PAUs



### Observation & Recommendation

- PAUs are interlocked with AHUs and operating with the same time schedule
- Delay in start-up of the PAUs can reduce cooling energy
- To modify the control logic PAUs
- PAUs will start only 15 minutes before the normal operating hours of the building

## Retro-commissioning (RCx)

### Example 8 - Air-conditioning (Air-side System)

➤ ESO: To adjust operation hours of Primary Air Handling Units



#### Energy Saving Estimation

- Potential saving of PAU fan power consumption (25kW)
- Potential saving from the chiller plant due to the reduction of cooling load from fresh air (120kW)
- Saving from operation of: delay start (1.25 hrs for Mon, 0.75 hrs for Tue to Fri)  
early stop (0.5 hrs for Mon to Fri)

Estimated Annual Energy Saving => **49,000 kWh**  
(~ 2.6 % of chiller plant annual energy consumption)

# Retro-commissioning (RCx)

## Example 9 - Air-conditioning (Air-side System)

- ESO: To review and adjust pressure setting for VAV systems



### Facility / Equipment



AHUs and VAV boxes



### Observation

- No reading on the air flow of some VAV boxes
- The position of air damper in such VAV box was fully opened
- The pressure sensors may be clogged or failed or deviated from design pressure/ flow rate

# Retro-commissioning (RCx)

## Example 9 - Air-conditioning (Air-side System)

- ESO: To review and adjust pressure setting for VAV systems

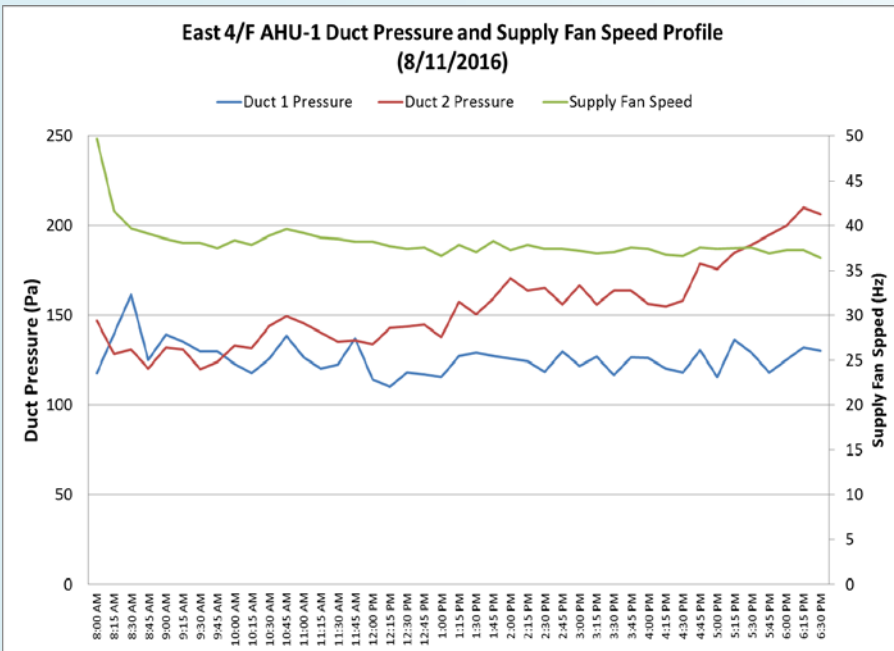

### Recommendation

- Repair/ replace faulty pressure sensors
- Review and adjust setting of VAV boxes
- Amount of air supplied by AHUs of VAV system could be reduced and lower the fan power consumption

## Retro-commissioning (RCx)

### Example 9 - Air-conditioning (Air-side System)

- ESO: To review and adjust pressure setting for VAV systems

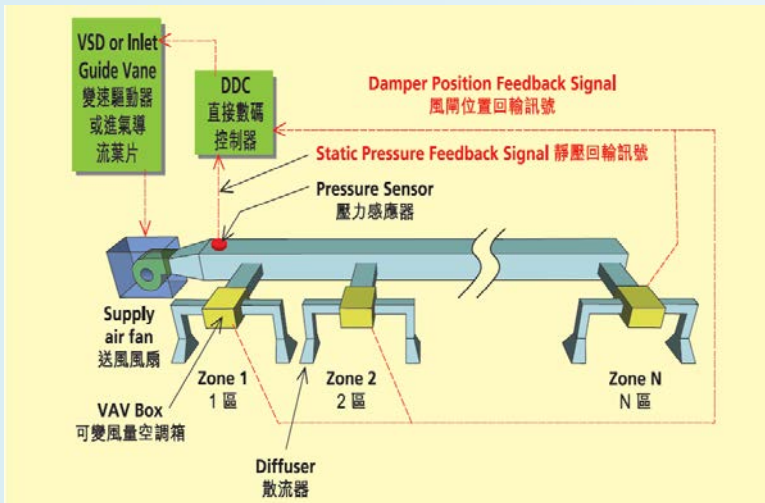

### Principle

- The damper position of VAV box shall vary according to the dynamics of cooling demand in the conditioned space
- If less cooling demand is required, the damper opening will reduce and the static pressure in the air duct will increase accordingly

# Retro-commissioning (RCx)

## Example 9 - Air-conditioning (Air-side System)

- ESO: To review and adjust pressure setting for VAV systems

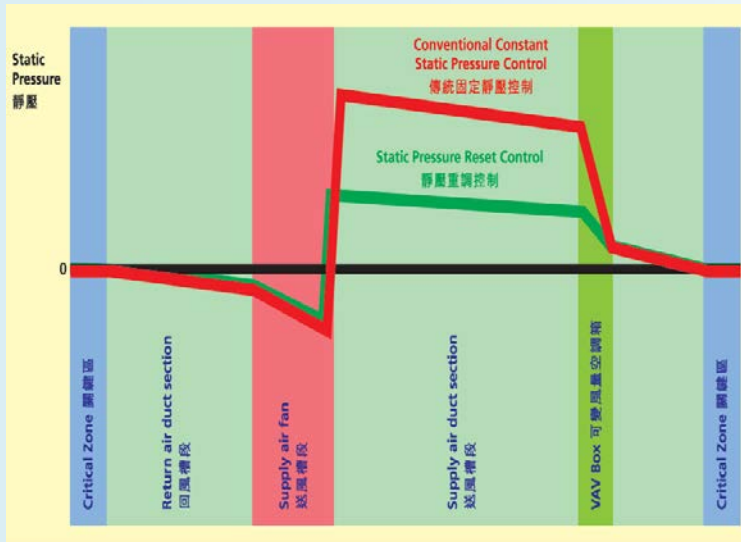

### Principle

- Under static pressure reset control, the volume of air delivered by VAV supply fan with variable speed drive will be reduced based on the pressure feedback signal
- The power consumption of VAV supply fan is thus reduced due to lower supply air flowrate

## Retro-commissioning (RCx)

### Example 9 - Air-conditioning (Air-side System)

- ESO: To review and adjust pressure setting for VAV systems

#### Energy Saving Estimation

- Estimated fan power saving from air side equipment : 18KW
- Saving from operation of 8 hours per day from Mon to Fri

Estimated Annual Energy Saving => **36,000 kWh**  
(~ 2 % of chiller plant annual energy consumption)



## Retro-commissioning (RCx)

### Example 10 - Air-conditioning (Water-side System)

- ESO: To setback chilled water supply temperature during non-office hour operation

#### Background Information

- 2 sets of air-cooled packaged screw type chillers (1 duty & 1 standby each with 300 kW cooling capacity) for the non-office hour operation
- Chilled water supply temperature of these chillers is designed and operated at 7°C.
- Operation schedule of chiller is listed below:

*Mon to Fri - 00:00 to 07:00 & 21:00 to 24:00*

*Sat - 00:00 to 07:00 & 17:00 to 24:00*

*Sun - 00:00 to 24:00*

## Retro-commissioning (RCx)

### Example 10 - Air-conditioning (Water-side System)

- ESO: To setback chilled water supply temperature during non-office hour operation



#### Facility / Equipment



Non office hour chiller



#### Observation

- The chilled water supply temperature is designed at 7°C in Summer
- Chilled water supply temperature can be higher during non-office hours for low cooling load

# Retro-commissioning (RCx)

## Example 10 - Air-conditioning (Water-side System)

➤ ESO: To setback chilled water supply temperature during non-office hour operation



### Facility / Equipment

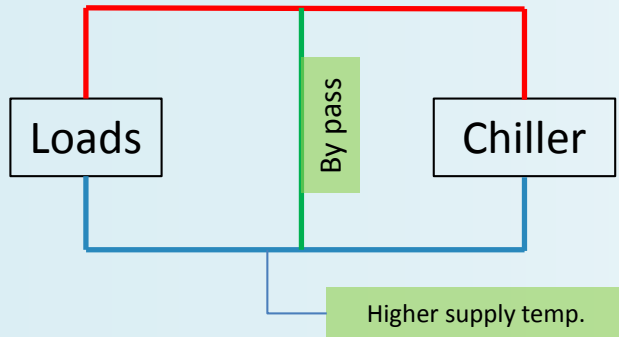

Simplified schematic  
(For indicative only)



### Recommendation

- Setting higher (2°C) chilled water supply temperature during non-peak hours

## Retro-commissioning (RCx)

### Example 10 - Air-conditioning (Water-side System)

- ESO: To setback chilled water supply temperature during non-office hour operation

#### Energy Saving Estimation

- Assume 6% saving on average chiller plant power consumption (~ 30kW)
- Annual operation hours : (5 days x 10 hrs + 14 hrs + 24 hrs) x 52 weeks = 4,576 hours

Estimated Annual Energy Saving => **8,000 kWh**  
(~ 0.5 % of chiller plant annual energy consumption)

# Retro-commissioning (RCx)

## Example 11 - Air-conditioning (Water-side System)

➤ ESO: To adjust the chilled water flowrate during non-office hours



### Facility / Equipment

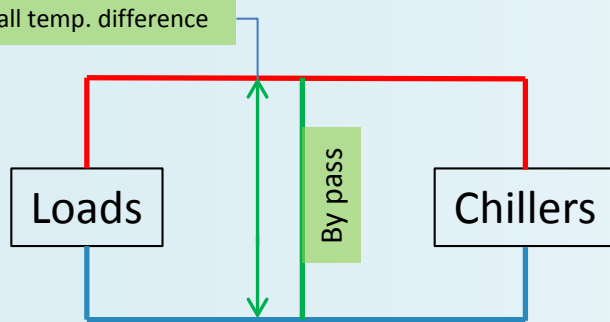

Simplified schematic  
(For indicative only)



### Observation

- Small temp. difference ( $2.7^{\circ}\text{C}$ ) between chilled water supply and return temperature at night mode
- Measured volume flow rate of chilled water supply is 20.7 l/s
- By keeping  $5^{\circ}\text{C}$  temperature difference, the required flow rate is 11.5 l/s only. The actual flow rate is almost doubled.

# Retro-commissioning (RCx)

## Example 11 - Air-conditioning (Water-side System)

- ESO: To adjust the chilled water flowrate during non-office hours

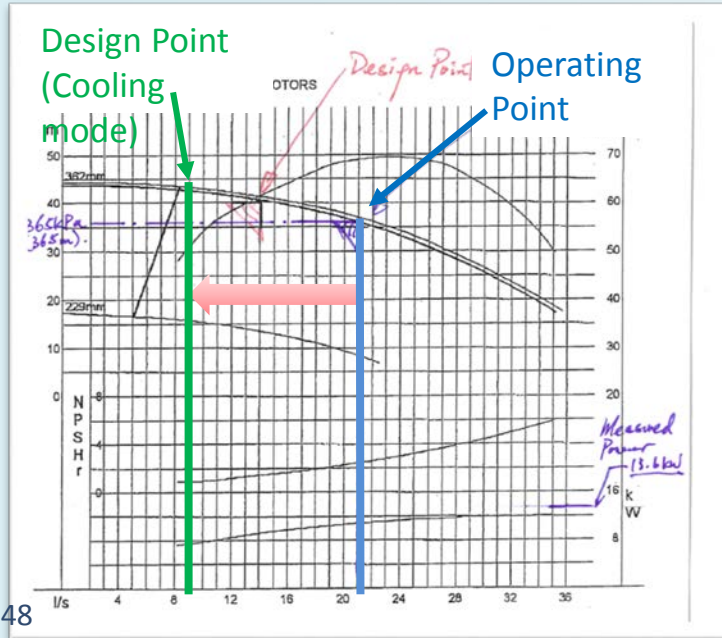

### Recommendation

- Pump flow rate can be reduced at non-office hour
- Power consumption of the chilled water pump will be saved.

## Retro-commissioning (RCx)

### Example 11 - Air-conditioning (Water-side System)

➤ ESO: To adjust the chilled water flowrate during non-office hours

#### Energy Saving Estimation

- Pump Power reduced from 13.5kW to 8.0kW
- Annual operation hours :  $(5 \text{ days} \times 10 \text{ hrs} + 14 \text{ hrs} + 24 \text{ hrs}) \times 52 \text{ weeks} = 4,576 \text{ hours}$

Estimated Annual Energy Saving => **25,000 kWh**  
(~ 1.5 % of chiller plant annual energy consumption)